

Kontener morski DRY 20 - Ściany czołowe - Skala 1:25

Rysował: Czarek Maruszak ASTRA28 Szczecin (www.astra28.eu)

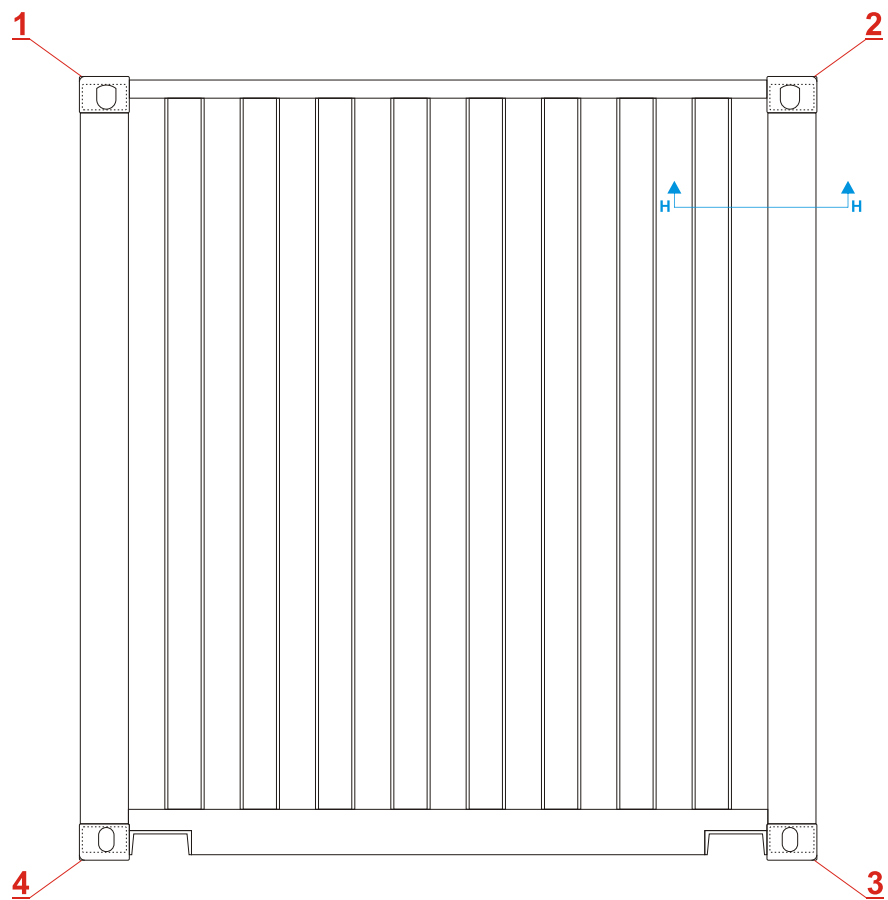

Ściana przednia

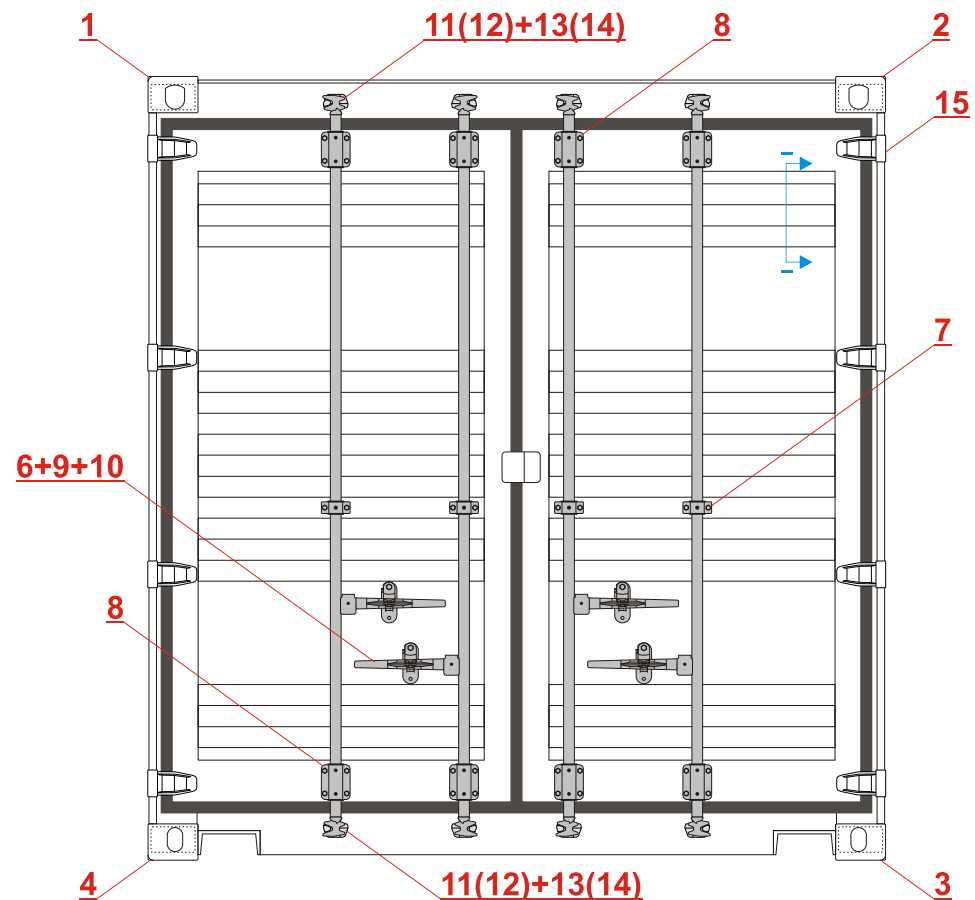

Ściana tylna - 5 ryfli

Kontener morski DRY 20 - Ściany czołowe - Skala 1:25

Rysował: Czarek Maruszak ASTRA28 Szczecin (www.astra28.eu)

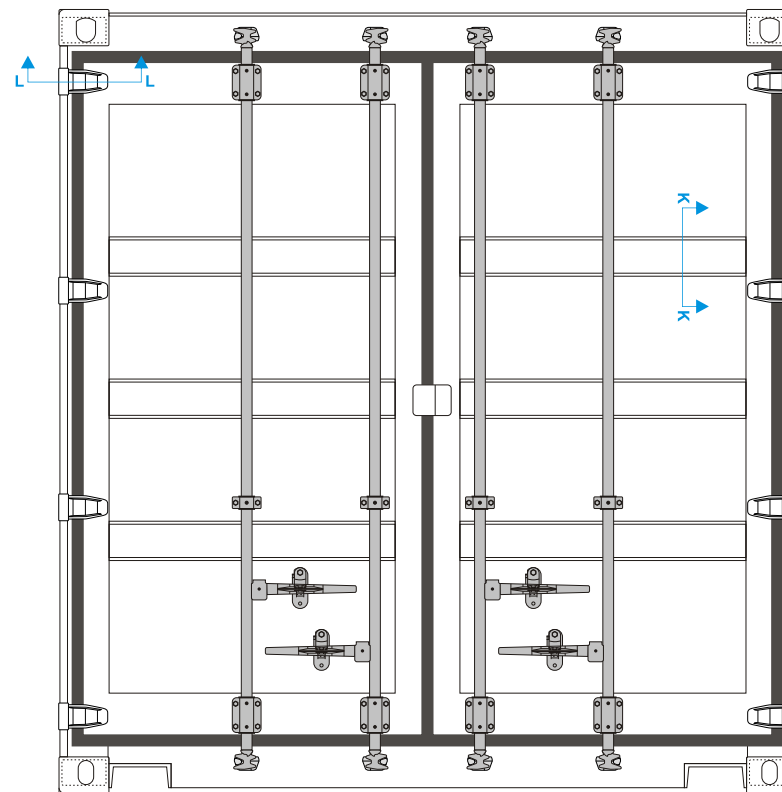
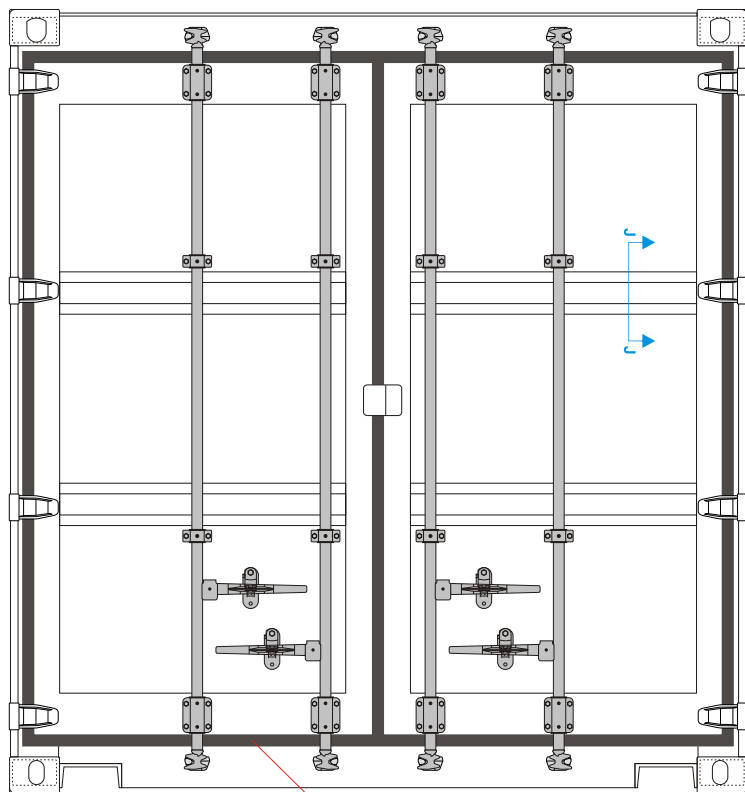

Gumowa uszczelka drzwi

Ściana tylna - 2 ryfle

Ściana tylna - 3 ryfle

Kontener morski DRY 20 - Ściana prawa - Skala 1:25

Rysował: Czarek Maruszak ASTRA28 Szczecin (www.astra28.eu)

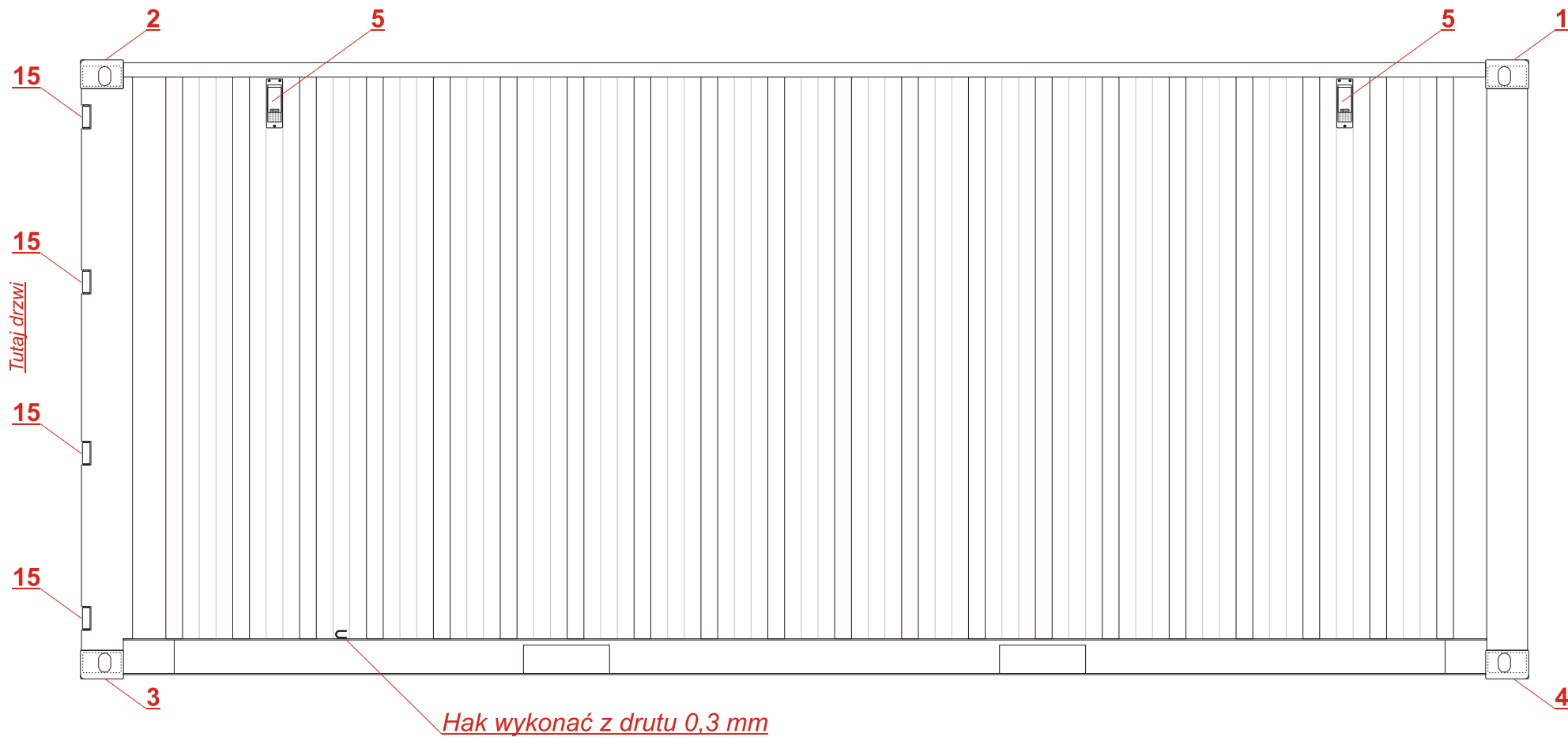

Kontener morski DRY 20 - Ściana lewa - Skala 1:25

Rysował: Czarek Maruszak ASTRA28 Szczecin (www.astra28.eu)

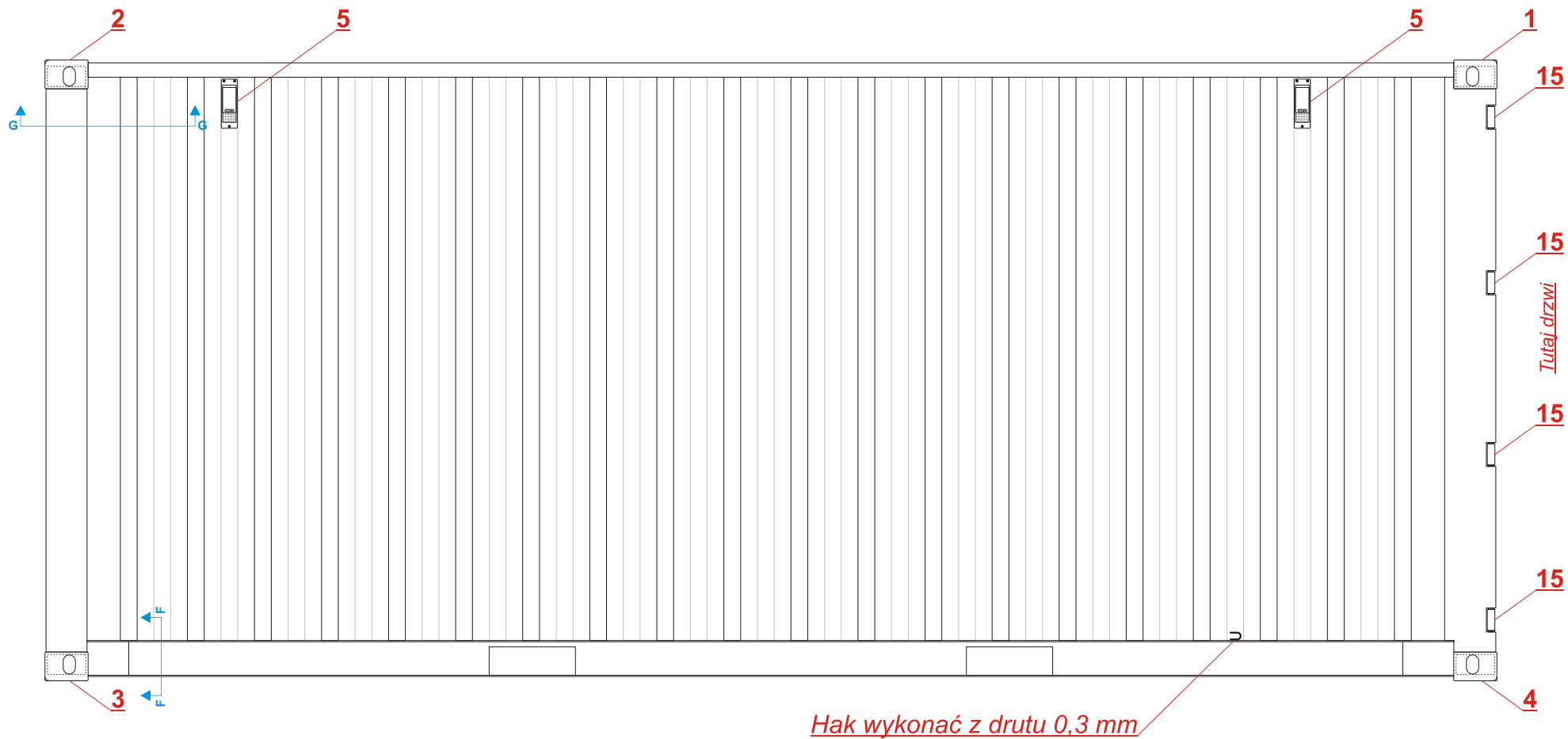

Kontener morski DRY 20 - Podłoga - Skala 1:25

Rysował: Czarek Maruszak ASTRA28 Szczecin (www.astra28.eu)

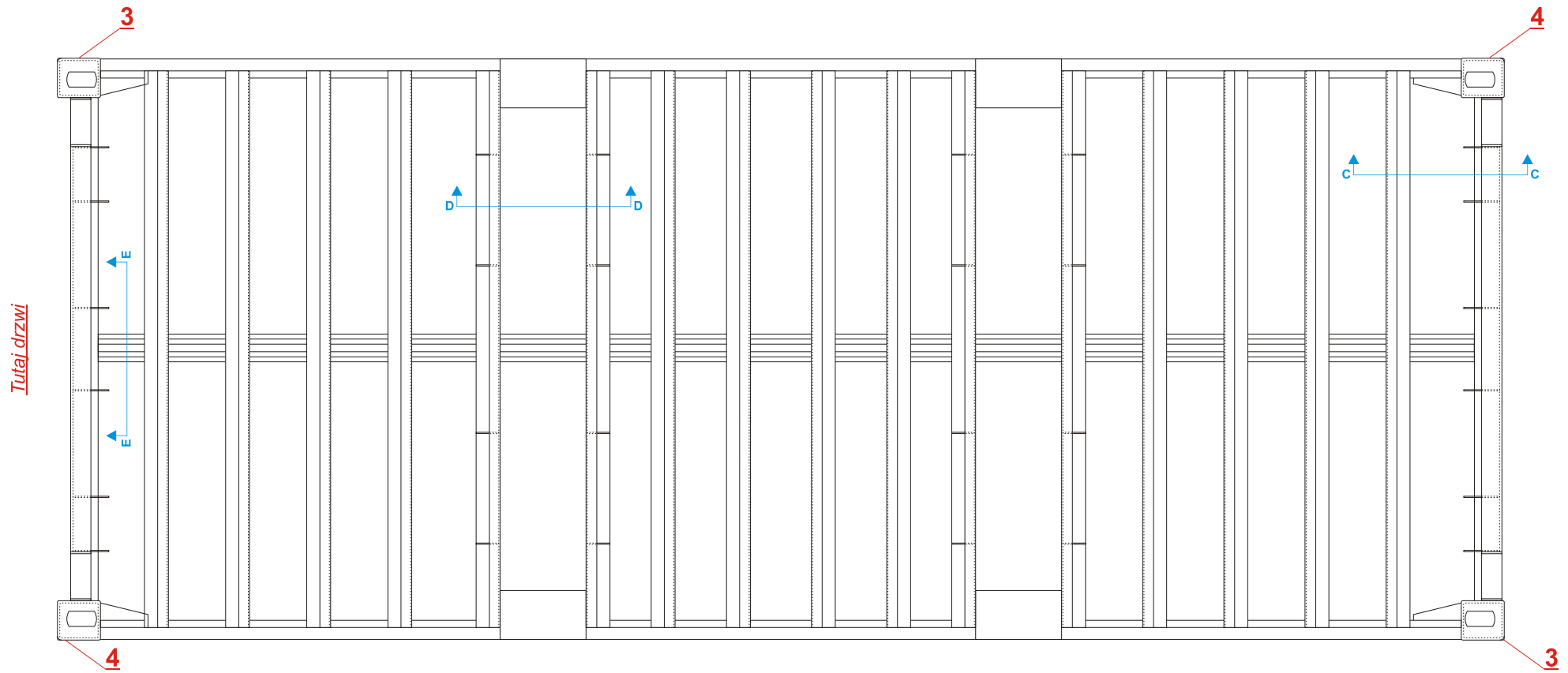

Podłoga w całości malowana na czarno lub bardzo ciemny brąz.



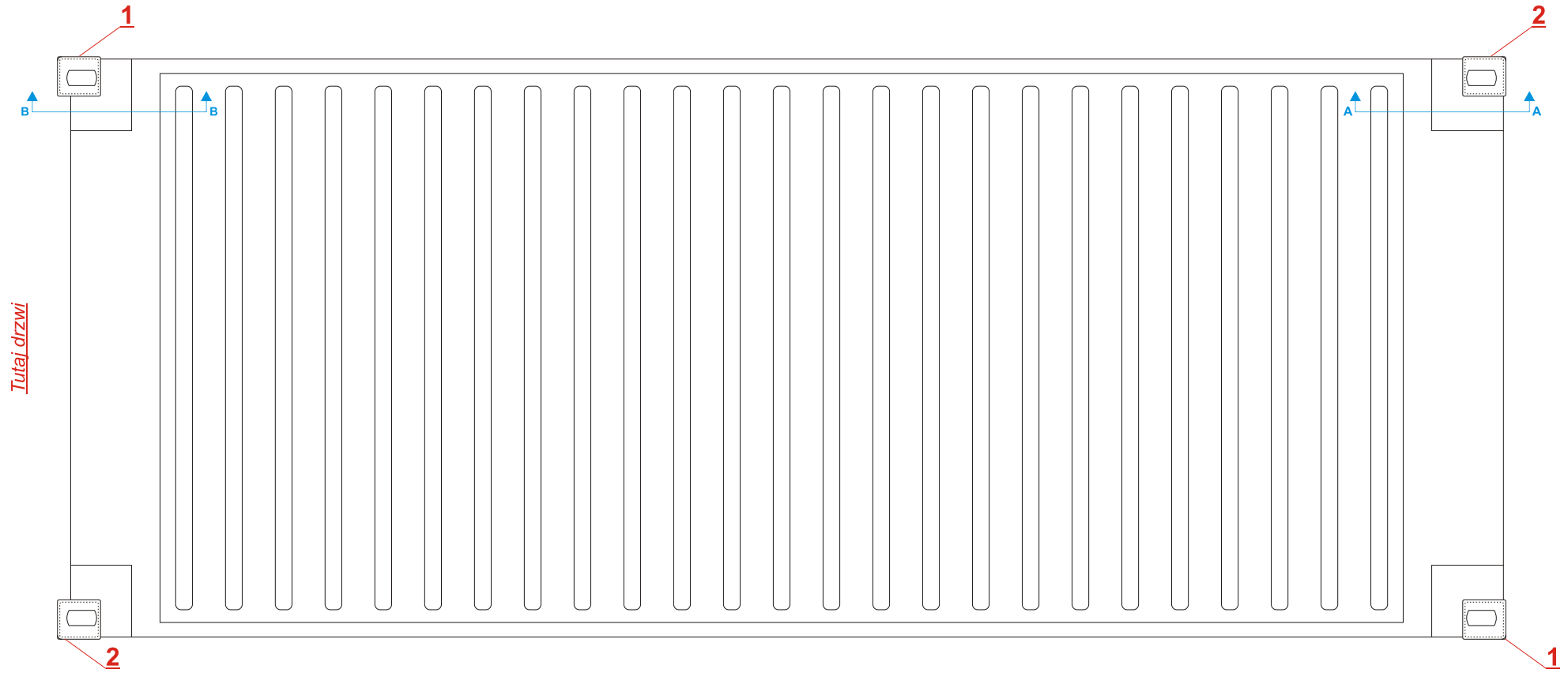

Kontener morski DRY 20 - Dach - Skala 1:25

Rysował: Czarek Maruszak ASTRA28 Szczecin (www.astra28.eu)

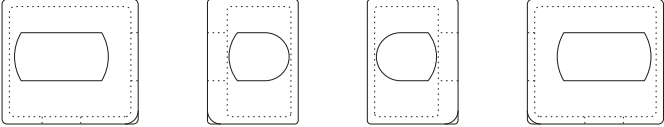
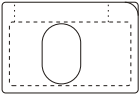
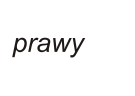
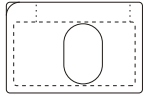
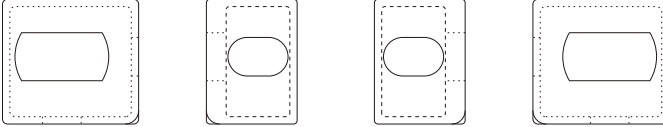
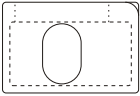

Kontener morski DRY 20 - Detale - Skala 1:10

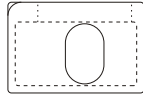
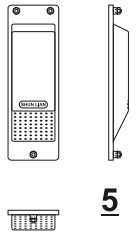
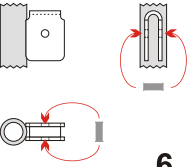
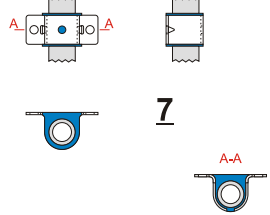
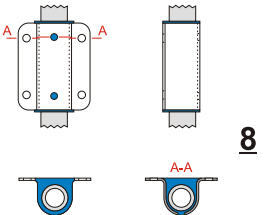
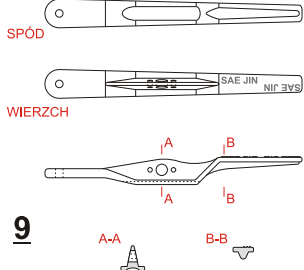
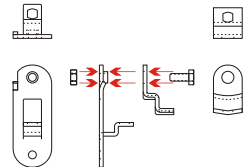
Rysował: Czarek Maruszak ASTRA28 Szczecin (www.astra28.eu)

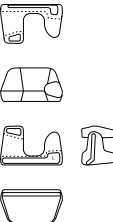
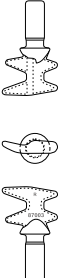
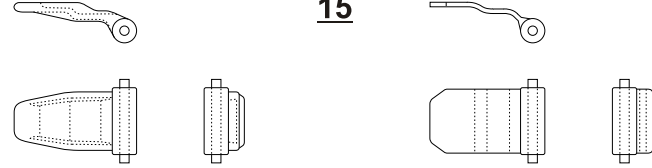
<p><u>NAROŻNIK GÓRNY</u></p> <p>1  2</p> <p> <i>lewy</i>  <i>prawy</i> </p>		<p><u>NAROŻNIK DOLNY</u></p> <p>3  4</p> <p> <i>prawy</i>  <i>lewy</i> </p>		<p><u>WYWIETRZNIK</u></p> <p> 5</p>	
<p><u>MOCOWANIE DŹWIGNI</u></p> <p> 6</p>	<p><u>OBEJMA MAŁA Z WKŁADKĄ PLASTIKOWĄ</u></p> <p> 7</p>	<p><u>OBEJMA DUŻA Z WKŁADKĄ PLASTIKOWĄ</u></p> <p> 8</p>	<p><u>DŹWIGNIA</u></p> <p> 9</p>	<p><u>ZAMEK CELNY Z ZARZUTKĄ</u></p> <p> 10</p>	<p><u>ŚRUBA M17 i NAKRĘTKA</u></p> <p></p>
<p><u>GNIAZDO RYGIELA</u></p> <p>11  12</p> <p><i>lewe</i> <i>prawe</i></p>		<p><u>RYGIEL</u></p> <p>13  14</p> <p><i>prawy</i> <i>lewy</i></p>		<p><u>ZAWIAS</u></p> <p>15 </p> <p><i>typ I</i> <i>typ II</i></p>	

Kontener morski DRY 20 - Przekroje - Skala 1:25

Rysował: Czarek Maruszak ASTRA28 Szczecin (www.astra28.eu)

